

## FOR INDUSTRY, FOOD PROCESSING & SPORTS HALLS

# SWEA

- ✓ HACCP certified for food processing environments
- ✓ IP66; IK10, ball impact proof for standard-compliant lighting in sports facilities
- ✓ Extruded aluminum heatsink, designed without cooling fins preventing dust collection and facilitating easy cleaning for the highest hygiene standards
- ✓ High energy efficiency, available up to 28.000 lumen, as doubled version up to 56.000 Lumen, DALI supported, Lifetime of 70,000 / 100,000 hours (L80/B10)
- ✓ Available in five light distributions, narrow beam (37°), medium beam (74°), wide beam (96°), opal beam (94°) and oval (22°, 100°)





## GENERAL SPECIFICATIONS

<b>Dimensions</b>	610 mm x 292 mm x 100 mm	1210 mm x 292 mm x 100 mm
<b>Luminous flux</b>	14000 lm	28000 lm
<b>System power</b>	109 - 136 W	218 - 272 W
<b>Luminous efficacy</b>	103 - 128 lm/W	103 -128 lm/W
<b>Colour temperature</b>	4000 K (3000 K and 5000 K on request)	
<b>CRI</b>	CRI > 80	
<b>Optics / Light distribution</b>	wide beam (96°), medium beam (74°), narrow beam (37°) or oval (22°, 100°) for an application at high shelves. narrow in cross and wide beam in length direction Precision lens optics and opal optic with wide beam (94°)	
<b>Cover material</b>	PMMA IK07; PC / clear tempered safety glass IK10	
<b>LED driver</b>	150 W, Standard and DALI, DC suitable, Lifetime 100.000 hours	
<b>Certifications</b>	CE; photobiological safety DIN EN 62471; D certification, HACCP certification, ball impact proof VDE 0710-13:1981-05 , Glow wire PC 850°C / ESG 960°C	
<b>Lifetime</b>	70,000 hours, lumen maintenance of 80 % (L80/B10) / oval Optic 100,000 hours (L80/B10)	
<b>Operating temperature</b>	-35 °C to +45 °C	
<b>Weight</b>	7.5 kg	15 kg
<b>Additional options</b>	Daylight presence control (DPC) & Presence control (PRC)	

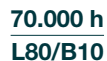

## ELECTRICAL SPECIFICATIONS

<b>Driver</b>	Standard and DALI
<b>Input</b>	230 V AC / DC
<b>Input voltage</b>	230 V 50 Hz
<b>PF, THD</b>	≤ 20, ≥ 0.9
<b>Surge protection</b>	4 kV

## DIMENSIONAL DRAWING

All measures in millimeter

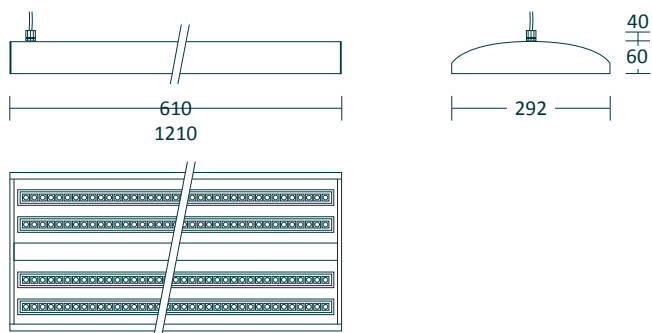

## ZUSÄTZLICHE SPEZIFIKATIONEN

<b>Housing material</b>	Eloxiertes Aluminiumgehäuse
<b>Cable (included)</b>	Standard 3 m (DALI 5 x 1.5 mm <sup>2</sup> ; Standard 3 x 1.5 mm <sup>2</sup> )
<b>Optional mounting accessory</b>	Chain or steel wire (3 m), direct ceiling mounting brackets, one point fixing

## LIGHT DISTRIBUTION

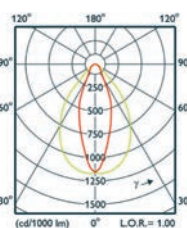

NB, Narrow beam (37°)

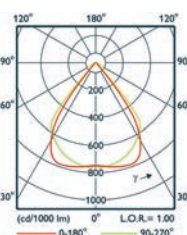

MB, Medium beam (74°)

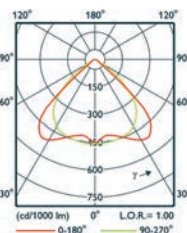

WB, Wide beam (96°)

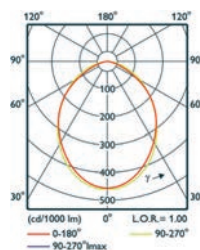

O, Opal (94°)

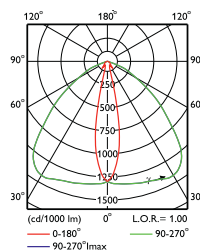

OV, Oval (22°, 100°)

## PREFERRED SELECTION

Type	System power (W)	Luminous flux (lm)	Luminous efficacy (lm/W)	Colour temperature (K)	CRI (R <sub>a</sub> )	Order Number
SWEA 14000LM 840 STD WB PMMA-PT	109,0	14000	128	4000	>80	911118104001
SWEA 14000LM 840 STD MB PMMA-PT	109,0	14000	128	4000	>80	911118104002
SWEA 14000LM 840 STD NB PMMA-PT	109,0	14000	128	4000	>80	911118104003
SWEA 14000LM 840 STD O PMMA-PT	124,0	14000	113	4000	>80	911118104004
SWEA 14000LM 840 STD OV PMMA-PT	136,0	14000	103	4000	>80	92005784
SWEA 14000LM 840 STD WB PC-PT	116,0	14000	121	4000	>80	911118104005
SWEA 14000LM 840 STD MB PC-PT	116,0	14000	121	4000	>80	911118104006
SWEA 14000LM 840 STD NB PC-PT	116,0	14000	121	4000	>80	911118104007
SWEA 14000LM 840 STD O PC-PT	133,0	14000	105	4000	>80	911118104008
SWEA 14000LM 840 STD OV PC-PT	136,0	14000	103	4000	>80	92005797
SWEA 14000LM 840 STD WB PC-PT BP	116,0	14000	121	4000	>80	911118104028
SWEA 14000LM 840 STD MB PC-PT BP	116,0	14000	121	4000	>80	911118104029
SWEA 14000LM 840 STD NB PC-PT BP	116,0	14000	121	4000	>80	911118104030
SWEA 14000LM 840 STD O PC-PT BP	133,0	14000	105	4000	>80	911118104031
SWEA 28000LM 840 STD WB PMMA-PT	218,0	28000	128	4000	>80	911118104053
SWEA 28000LM 840 STD MB PMMA-PT	218,0	28000	128	4000	>80	911118104056
SWEA 28000LM 840 STD NB PMMA-PT	247,5	28000	113	4000	>80	911118104057
SWEA 28000LM 840 STD O PMMA-PT	247,5	28000	113	4000	>80	911118104058
SWEA 28000LM 840 STD WB PC-PT	233,0	28000	120	4000	>80	911118104059
SWEA 28000LM 840 STD MB PC-PT	233,0	28000	120	4000	>80	911118104060
SWEA 28000LM 840 STD NB PC-PT	265,0	28000	106	4000	>80	911118104061
SWEA 28000LM 840 STD O PC-PT	265,0	28000	106	4000	>80	911118104062
SWEA 28000LM 840 STD WB PC-PT BP	233,0	28000	120	4000	>80	911118104089
SWEA 28000LM 840 STD MB PC-PT BP	233,0	28000	120	4000	>80	911118104090
SWEA 28000LM 840 STD NB PC-PT BP	265,0	28000	106	4000	>80	911118104091
SWEA 28000LM 840 STD O PC-PT BP	265,0	28000	106	4000	>80	911118104092

Available: ESG-PT, DPC, PRC, DALI, 56.000 lm

## ACCESSORIES

Type	Order number	Index
SWEA SWA D1,2 L3000 SET	911118104025	1
SWEA SWA D2 L3000 SET	911118104026	2
SWEA MB-SFM SET	911118104027	3
SWEA MB ONE-POINT-SUSPENSION-BRACKET	911118104048	4
SWEA MB-SFM Swivel Bracket SET	911118104049	5

1 set per luminaire required

